



EXTERIOR DOORS



Quality

The latest technology, the best materials and production control at each stage, as well as, our own research laboratories are the guarantees of quality.



Service

Professional and fast service is Drutex's calling card, which has been setting trends in pre- and post-sale customer services for many years now.



Security

The doors are equipped with reliable fittings and locks, which ensures security.



Smart Home

Intelligent control of doors, windows, roller shutters, venetian blinds, mosquito nets, gates, wickets, and lighting by means of a smartphone.



Official Partner of FC Bayern

31 Leborska Street, 77-100 Bytow
+48 59 822 91 01

SINCE 1985

The information presented in this advertising material are informative and illustrative only. The product specification should be verified with the technical data specified by the manufacturer.

EXTERIOR DOORS

MADE OUT OF PASSION AND EXPERIENCE



TABLE OF CONTENTS



ALUMINIUM DOORS

MB-86 SI System	06
Art Line NEW	08
MB-79N SI+ System	12
MB-45 System (cold)	14
Infill Designs	20
Extra Equipment	38
Colour Scheme	40



PVC DOORS

Iglo Edge	48
Iglo Energy	50
Iglo 5	52
Infill Designs	54
Veneer Colours	64



WOODEN DOORS

Softline 68	72
Softline 78	72
Softline 88	72
Colour Scheme	75



EXTRAS

Glass	78
Sandblasted Glass	80
Pull Handles	84
Handles	86
Access Control	88
Thresholds	90
Extra Equipment	94



EXTRA POSSIBILITIES

Doors with Extra Security Equipment	96
Fire-Rated Doors	98
Door Constructions	100
Anti-Panic Fittings	102
Door Mullions in:	
Aluminium and PVC	104
Wooden Doors	108

SYSTEM COMPARISON 110

SEE ALSO 112

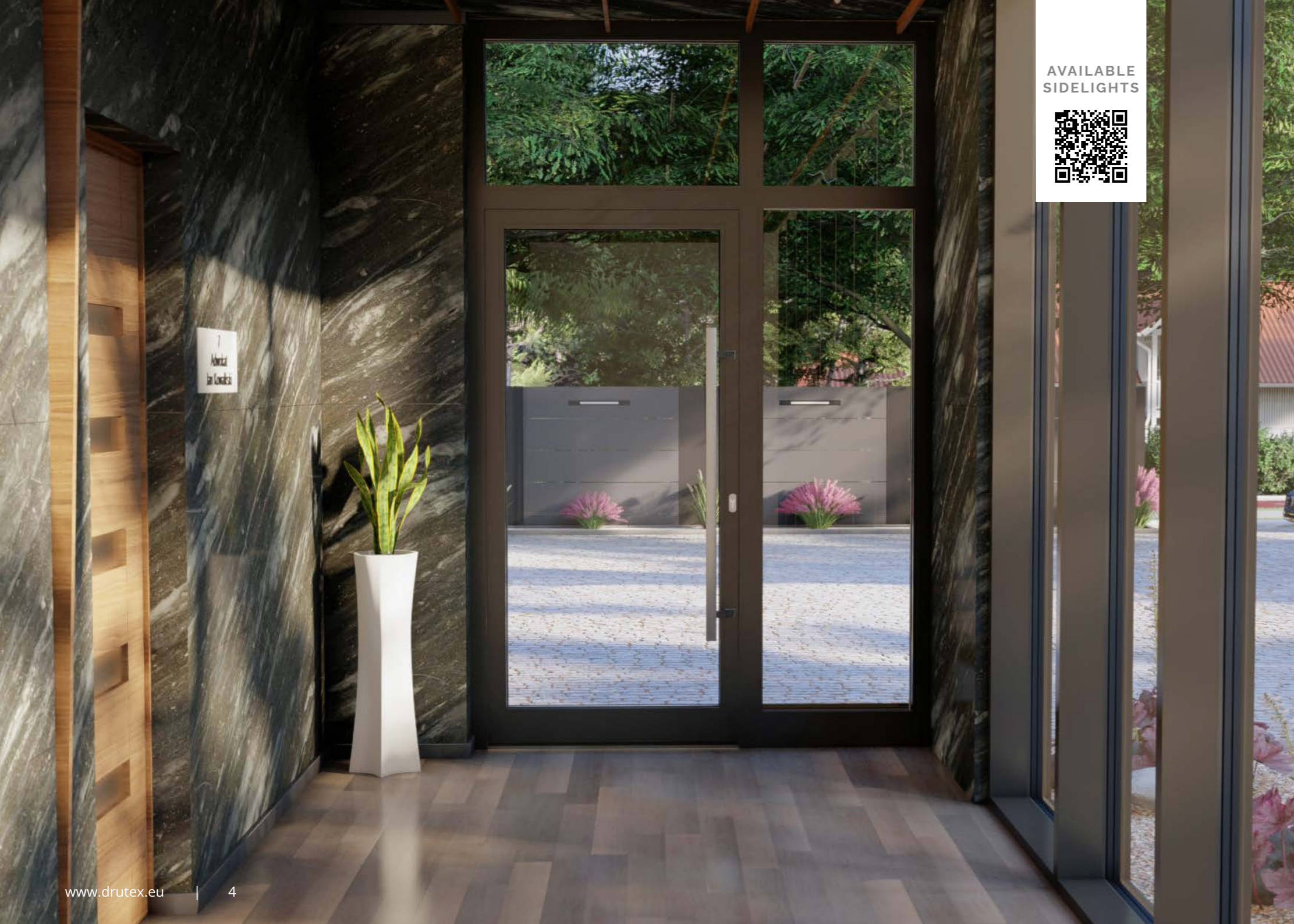

AVAILABLE
SIDELIGHTS



ALUMINIUM DOORS

Drutex aluminium doors are a great choice for supporters of innovative technologies, with varied arrangement and utility possibilities, modern design and security. Components and equipment, used in the process of production, combined with the highest quality standards, allowed to create products that meet the ideas and needs of the most demanding customers.

INFILLS

p. 16

EXTRAS

p. 34

COLOUR SCHEME

p. 36

MB-86 SI SYSTEM

Exterior doors in this system, with a threshold equipped with a thermal break, are characterised not only by exceptional quality in terms of thermal insulation, but also durability. Hence these doors are recommended for energy-saving constructions.

TECHNICAL DATA



77 mm
installation
depth



Ud = 0,83 W/(m²K)*
thermal
transmittance







* More data at p. 110.



SYSTEM STRUCTURE

The profiles have a three-chamber structure with a structural depth of door sections of 77 mm and a thermal break made of polyamide reinforced with fiberglass.

Extra Options Available:





-  Swissspacer Ultimate warm spacing edge in 3 colour variants.
-  3-winged, roller and hidden hinges (invisible when the door is closed).
-  Sidelights (p. 100-101).
-  A wide range of RAL colours, special colours and structures (p. 40).
-  Both-side alignment.
-  15 mm to 69 mm thick infill (glass), 77 mm thick overlay panel, and 36 mm thick batch panel.

S As Standard:

- 3-point espagnolette
- 3 two-winged hinges
- Ug = 1,1 W/(m²K) glass
- Standard colours: RAL 7016 and 9016 matt paint
- threshold with a thermal break
- aluminium handle
- mounting insert.

77 mm thick both-side aligned batch panel.



-  Optional drop seal available
-  Available in two insulation types: ST or SI
-  Glass with increased acoustic insulation, toughened, laminated (safety and anti-burglary), ornamental, sun protective, and sandblasted glass.
-  An espagnolette with a motor, equipping it to work with a smart access system.
-  A "day/night" type of espagnolette (recommended when choosing a pull handle).



MORE INFORMATION



NEW

D-ART LINE SYSTEM

A new generation of premium-class doors
– technology, design, excellence.



SAMPLE DESIGNS



D-ART LINE ELEGANCE 2

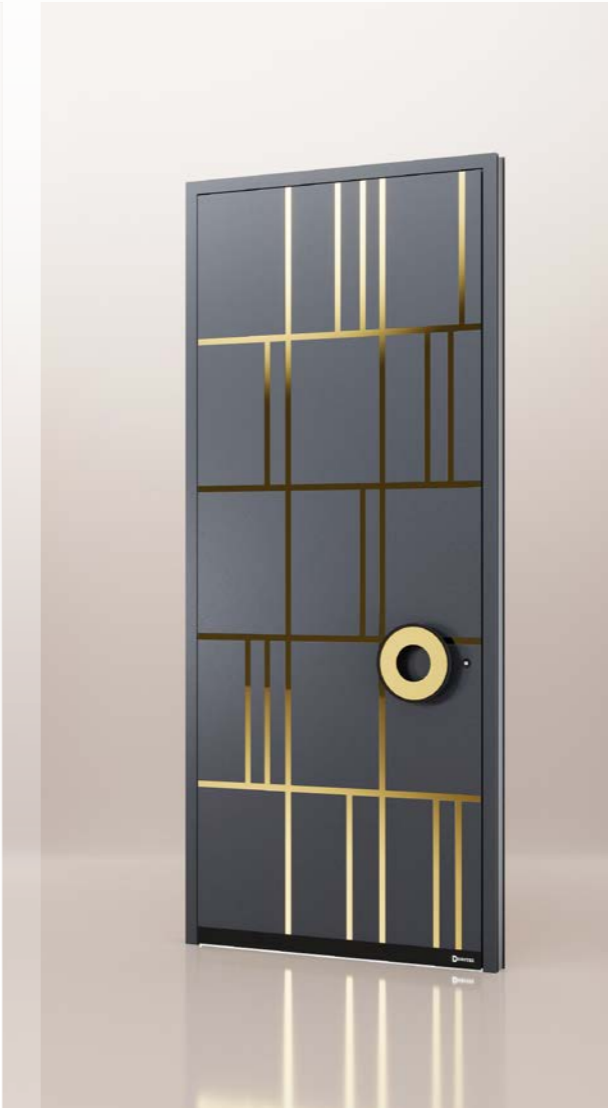

D-ART LINE PRESTIGE 2



D-ART LINE PRESTIGE 3

SAMPLE DESIGNS



D-ART LINE CLASSIC 6



D-ART LINE MODERN 5



D-ART LINE ELEGANCE 1



BEAUTY LIES IN THE DETAIL

D-ART LINE ELEGANCE 1



SEE ALL AVAILABLE D-ART LINE
DESIGNS

DOWNLOAD THE CATALOGUE



MB-79N SI SYSTEM

Single or double leaf doors made in this system meet increased thermal and acoustic requirements, which can be attributed to its structure with applied sealing including a threshold with a thermal break.

TECHNICAL DATA



70 mm
installation
depth



Ud = 1,0 W/(m²K)*
thermal
transmittance

* More data at p. 110.



SYSTEM STRUCTURE

The structural depth of the leaf sections and the frame is the same and amounts 70 mm. The structure provides for alignment with both of the sections either from the outside or from the inside. The leaf profiles dilate so that thermal strains, which occur during use, are eliminated.

Extra Options Available:

- Swisspacer Ultimate warm spacing edge in 3 colour variants.
- 3-winged, roller and hidden hinges (invisible when the door is closed).
- Sidelights (p. 100-101).
- A wide range of RAL colours, special colours and structures (p. 40).
- 16 mm to 53 mm thick infill (glass) and 36 mm thick batch panel.

S As Standard:

- 3-point espagnolette
- 3 two-winged hinges
- Ug = 1,1 W/(m²K) glass
- threshold with a thermal break
- Standard colours: RAL 7016 and 9016 matt paint
- aluminium handle
- mounting insert.

36 mm thick
batch panel.



D

- Optional drop seal available
- Available in three insulation types: ST, SI or SI+
- An espagnolette with a motor, equipping it to work with a smart access system.
- Glass with increased acoustic insulation, toughened, laminated (safety and anti-burglary), ornamental, sun protective, and sandblasted glass.
- A "day/night" type of espagnolette (recommended when choosing a pull handle).



MORE INFORMATION



MB-45 SYSTEM (COLD)

Doors in this system, due to the construction of one-chamber profiles without a thermal break, are recommended mainly for inside buildings in places which do not need to meet high thermal insulation parameters e.g. for building partition walls, vestibules, showcases, checkout counters, or glass-cases.

TECHNICAL DATA



45 mm
installation
depth





* More data at p. 110.



SYSTEM STRUCTURE

The depth of the leaf and frame sections, amounting to 45 mm in both of these elements, allows for aligned surfaces results. The narrow profile gives a visual lightness to the construction, which perfectly fits into the current design trends.

Extra Options Available:

-  Swisspacer Ultimate warm spacing edge in 3 colour variants.
-  3-winged hinges.
-  Single 6 mm thick glass.
-  A wide range of RAL colours, special colours and structures (p. 40).
-  6 mm to 28 mm thick infills.

S As Standard:

- 3-point espagnolette
- 3 two-winged hinges
- threshold
- RAL 7016 and 9016 matt paint
- aluminium handle
- mounting insert.

24.5 mm thick glass.

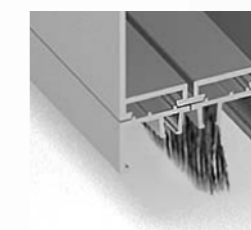

Brush as additional option.



Optional drop seal available



Glass with increased acoustic insulation, toughened, laminated (safety and anti-burglary), ornamental, sun protective, and sandblasted glass.



Sidelights (p. 100-101).

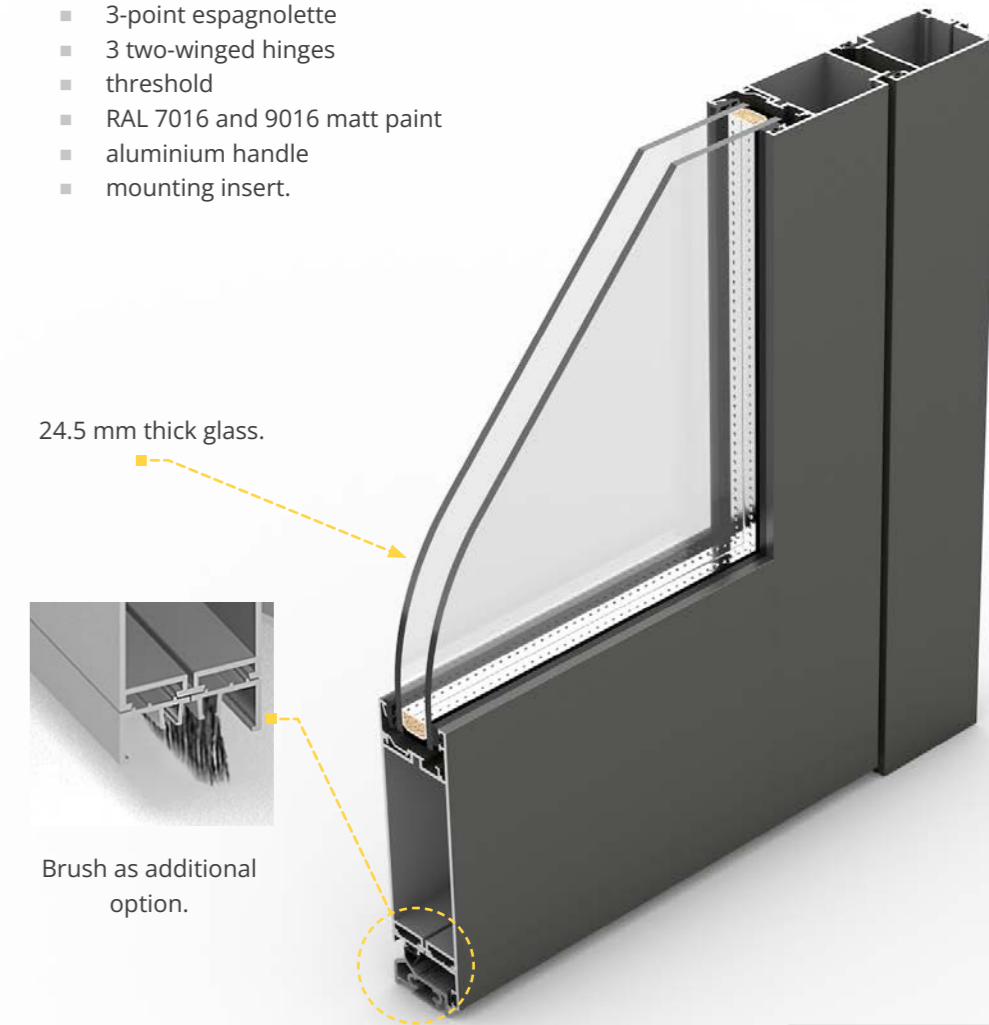

D

MORE
INFORMATION



ALUMINIUM SYSTEM



MB-79N SI+ System



MB-79N SI+ System



ALUMINIUM SYSTEM

MB-79N SI+ System



MB-86 SI System



ALUMINIUM DOORS INFILL DESIGNS

In the aluminium doors offer, Drutex has several dozen infill models available, with glazing or stainless steel applications. Due to the wide range, doors can be perfectly designed to compliment the building style and architecture. Varied colour options, depending only on the client's taste, enables almost infinite arrangement possibilities. 4-glass package as standard.



Panels without cutters may be equipped with steel application.



MAXIMAL AND MINIMAL
DOORS AND INFILLS
DIMENSIONS.

i Each glazing spacer bar is available in grey (INOX) or black.



WASHINGTON ZERO



WASHINGTON WOOD (L) (R)

Possible to order in mirror image.
Wood design only from the outside.



WASHINGTON 1*



WASHINGTON 2*



WASHINGTON 3 (L) (R)*

Possible to order in mirror image.



WASHINGTON 4*

Possible to order in mirror image.

L - Left **R** - Right **C** - Center - configuration of the pattern position relative to the center of the panel.

* Flush-mounted Inox application on the sheet surface.

ALUMINIUM DOORS INFILL DESIGNS

i Each glazing spacer bar is available in grey (INOX) or black.



WASHINGTON 6



WASHINGTON 7



WASHINGTON 8



WASHINGTON POCKET (L) (R)*



ALASKA 1



**ALASKA 1
DECORATIVE FRAME**



ALASKA 2



**ALASKA 2
DECORATIVE FRAME**

L - Left **R** - Right **C** - Center - configuration of the pattern position relative to the center of the panel.

* Flush-mounted Inox application on the sheet surface.

ALUMINIUM DOORS INFILL DESIGNS

i Each glazing spacer bar is available in grey (INOX) or black.



ALASKA 3 (L) (R)

The option to order in mirror image.



ALASKA 4



**ALASKA 4
DECORATIVE FRAME**



ALASKA 5 (L) (R)

The option to order in mirror image.



ARIZONA 1



**ARIZONA 1
DECORATIVE FRAME**



ARIZONA 2



**ARIZONA 2
DECORATIVE FRAME**

L - Left **R** - Right **C** - Center - configuration of the pattern position relative to the center of the panel.

* Flush-mounted Inox application on the sheet surface.

ALUMINIUM DOORS INFILL DESIGNS

i Each glazing spacer bar is available in grey (INOX) or black.



CALIFORNIA 5
(L) (R) (C)



CALIFORNIA 5
DECORATIVE FRAME
(L) (R) (C)



CALIFORNIA 6
(L) (R) (C)



CALIFORNIA 6
DECORATIVE FRAME
(L) (R) (C)



COLORADO 1
DECORATIVE FRAME (C)

The option to choose option without INOX.



FLORIDA 1 (L) (R)

The option to order in mirror image.

L - Left **R** - Right **C** - Center - configuration of the pattern position relative to the center of the panel.

* Flush-mounted Inox application on the sheet surface.



ALUMINIUM DOORS INFILL DESIGNS

i Each glazing spacer bar is available in grey (INOX) or black.



**FLORIDA 1
DECORATIVE FRAME
(L) (R)**

The option to order in mirror image.



FLORIDA 2 (L) (R)*

The option to order in mirror image.



FLORIDA 3 (L) (R)*

The option to order in mirror image.



FLORIDA 4 (L) (R)*

The option to order in mirror image.



HAWAII 1



**HAWAII 1
DECORATIVE FRAME (C)**

L - Left R - Right C - Center - configuration of the pattern position relative to the center of the panel.

* Flush-mounted Inox application on the sheet surface.



ALUMINIUM DOORS INFILL DESIGNS

i Each glazing spacer bar is available in grey (INOX) or black.



**HAWAII 2
DECORATIVE FRAME (C)**



**HAWAII 3
DECORATIVE FRAME (C)**



HAWAII 4*



HAWAII 5 (L) (R)*

Horizontal cutter on the whole leaf width,
The option to order in mirror image.



MONTANA 1

L - Left R - Right C - Center - configuration of the pattern position relative to the center of the panel.

* Flush-mounted Inox application on the sheet surface.



ALUMINIUM DOORS INFILL DESIGNS

i Each glazing spacer bar is available in grey (INOX) or black.



MONTANA 4*



MONTANA WOOD

Wood design only from the outside.



**MONTANA 1
DECORATIVE FRAME**



**MONTANA 2
DECORATIVE FRAME
(R) (L)**

The option to order in mirror image.



**MONTANA 3
DECORATIVE FRAME
(R) (L)**

The option to order in mirror image.



MINNESOTA 1

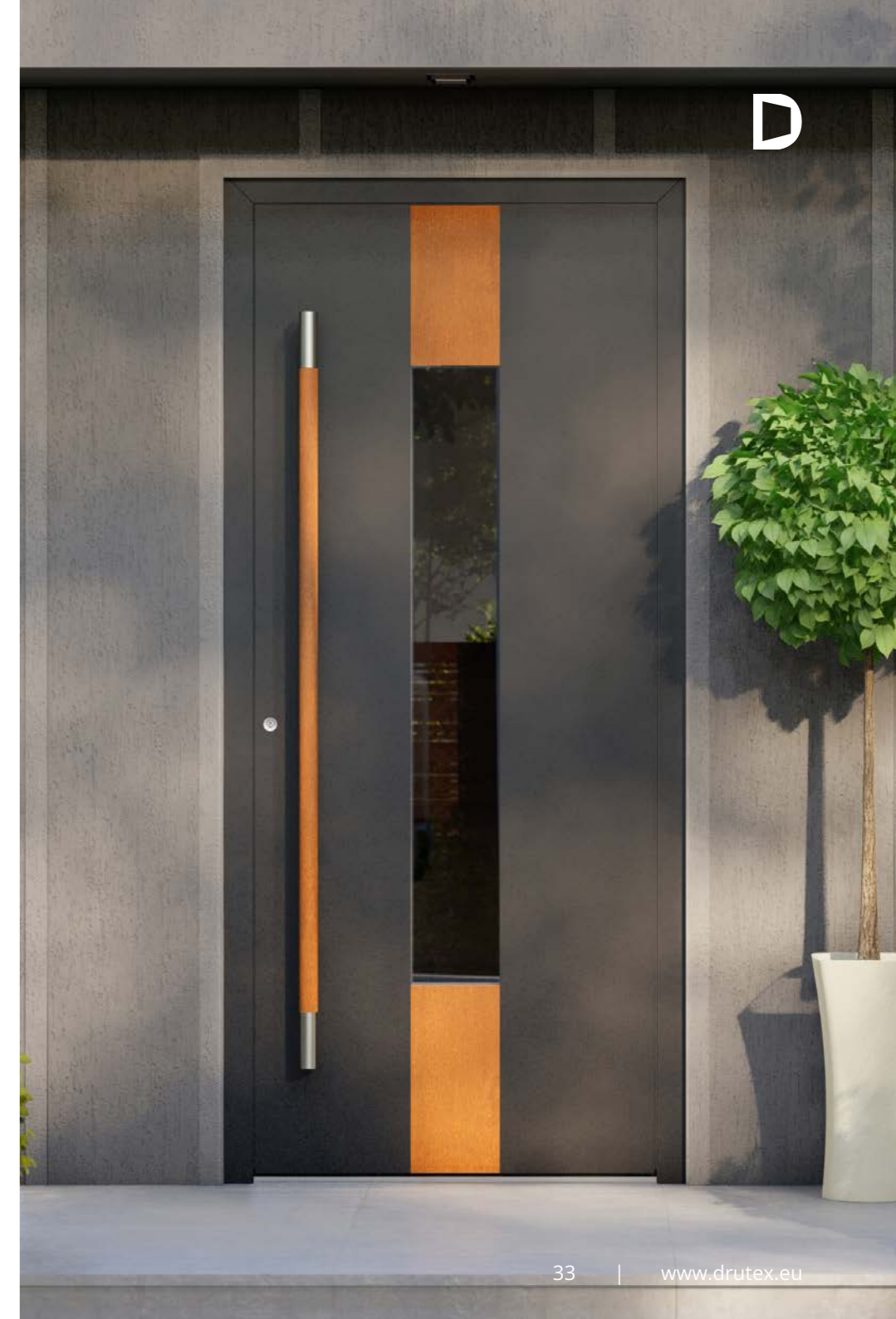

L - Left R - Right C - Center - configuration of the pattern position relative to the center of the panel.

* Flush-mounted Inox application on the sheet surface.

ALUMINIUM DOORS INFILL DESIGNS

i Each glazing spacer bar is available in grey (INOX) or black.



NEW YORK 1 (L) (R) (C)



NEW YORK 2 (L) (R)

The option to order in mirror image.



NEBRASKA 1 (L) (R) (C)

The option to order in mirror image.



**NEBRASKA 1
DECORATIVE FRAME
(L) (R) (C)**

The option to order in mirror image.
Only available with selected pull handles.



**NEW JERSEY 1
DECORATIVE FRAME**

The option to choose without INOX.
Only a steel spacing edge can be used.



TEXAS (L) (R) (C)



**TEXAS
DECORATIVE FRAME
(L) (R) (C)**

The option to order in mirror image.
Only available with selected pull handles.



TEXAS WOOD (L) (R)

The option to order in mirror image.
Wood design only from the outside.

L - Left R - Right C - Center - configuration of the pattern position relative to the center of the panel.

* Flush-mounted Inox application on the sheet surface.

ALUMINIUM DOORS INFILL DESIGNS

i Each glazing spacer bar is available in grey (INOX) or black.



**OHIO
DECORATIVE FRAME**



**PENNSYLVANIA 1
DECORATIVE FRAME**



PENNSYLVANIA 2 (L) (R)
The option to order in mirror image.



**PENNSYLVANIA 2
DECORATIVE FRAME
(L) (R)**
The option to order in mirror image.



**PENNSYLVANIA 3
DECORATIVE FRAME
(L) (R)**
The option to order in mirror image.



PENNSYLVANIA 4
Only glass with matt foil available.



PENNSYLVANIA 5 (L) (R)
The option to order in mirror image.



PENNSYLVANIA 6
Only glass with matt foil available.

L - Left R - Right C - Center - configuration of the pattern position relative to the center of the panel.

* Flush-mounted Inox application on the sheet surface.

ALUMINIUM DOORS EXTRA EQUIPMENT

The functions, utility values, aesthetics, functionality and comfort of using the doors are also determined by extra equipment in the form of hinges, anti-burglary fittings, rosettes, thresholds, or smart control access systems. The wide range of choices can meet with all door designs.

DOORS WITH ALIGNED PANEL



Both-side aligned panel,
77 mm thick.

DOORS WITH BATCH PANEL



36 mm thick
batch panel.

EXTRA OPTIONS AVAILABLE:



Sandblasted glass.



Hidden hinges invisible
when the door is closed.



Anti-theft bolt.



Panel with cutters of 6 mm
and more width (12 mm
as standard).



Ring rosette, emergency
function insert.



Stainless steel INOX
application.



"Day/night" type of
solutions.



Smart access systems.*



Door closer

*More at p. 95.

AVAILABLE COLOUR SCHEME

RAL 7016 MATT AND 9016 MATT
AS STANDARD

In the interest of producing the highest quality doors, based on one of the world's most modern powder coating plants, Drutex offers a wide range of paint coatings colours. Among them, depending on the expected aesthetics, metallic paints with structure, matt paints, or even paints ensuring special effects.

COLOUR PALETTE



ILLUSTRATIVE METALLIC PAINTS WITH STRUCTURE

Get a modern industrial vibe.



ILLUSTRATIVE SMOOTH MATT PAINTS

Create an aesthetic matt finish.

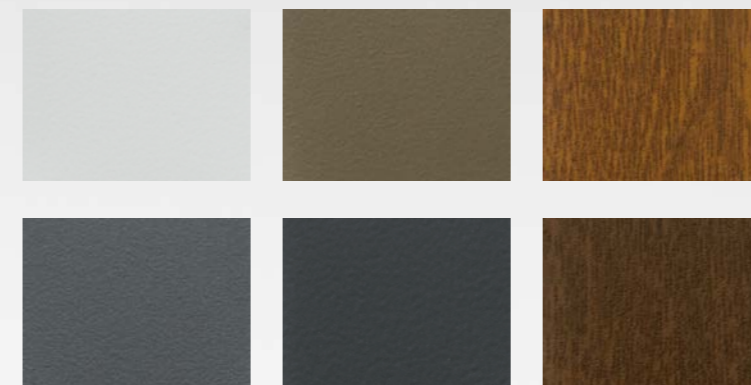

ALUMINIUM SYSTEM

Facade with venetian blinds, MB-86 SI doors with fanlight, New York 2 model, anthracite colour.



Facade with venetian blinds, MB-86 SI doors with sidelight and fanlight, Texas INOX model, light grey colour.



ALUMINIUM SYSTEM

Facade with venetian blinds, MB-86 SI doors with sidelight and fanlight, Pennsylvania 4 model, anthracite colour.



Aluminium facade, MB-86 SI doors with sidelight and fanlight, New York 1 model, anthracite colour.





PVC DOORS

Drutex's PVC doors are based on the original IGLO systems produced only from primary material guaranteeing optimal parameters in terms of stability, durability, lasting, and energy efficiency. Its additional advantage is the high acoustic insulation level. Owing to the wide colour scheme based on reputable Renolit foils, varied infills and modern fittings, as well as multiple extra equipment options, the doors can perfectly match a building's architecture and interior aesthetics.

INFILLS

p. 54

COLOUR SCHEME

p. 64

EXTRAS

p. 78

IGLO EDGE SYSTEM

Our new, most technologically advanced window is distinguished by an excellent thermal insulation parameter of $U_w = 0,66 \text{ W}/(\text{m}^2\text{K})^*$ and a modern, angular profile shape. The extremely good thermal insulation parameters are due, among other things, to the 7-chamber profile design and 3 EPDM gaskets, including the central gasket.



The option of producing the doors using V-Perfect technology (so-called thin weld).

TECHNICAL DATA



82 mm

installation depth



24-48 mm

input panel thickness



$U_d = 0,81 \text{ W}/(\text{m}^2\text{K})^*$

thermal transmittance

* More data at p. 111.



SYSTEM STRUCTURE

Frame made of 7-chamber PVC system.
Installation depth of the system amounts to 82 mm.

Extra Options Available:

- Swisspacer Ultimate warm spacing edge in 3 colour variants.
- Client proposed infill design made of mullions, glass and infill panel.
- A wide range of Renolit foil colours on white and brown core (p. 64).
- 3-winged hinges.
- 22,5 mm to 49,5 mm thick infill (glass) and 24, 36 or 48 mm thick batch panel.
- Glass with increased acoustic insulation, toughened, laminated (safety and anti-burglary), ornamental, sun protective, and sandblasted glass.
- Sidelights (p. 100-101).
- An espagnolette with a motor, equipping it to work with a smart access system.
- A "day/night" type of espagnolette (recommended when choosing a pull handle).

* 1 mm aluminium thermal break available as an option

S As Standard:

- 3-point espagnolette
- 3 two-winged hinges
- $U_g = 0,5 \text{ W}/(\text{m}^2\text{K})$
- threshold with a thermal break
- aluminium handle
- mounting insert

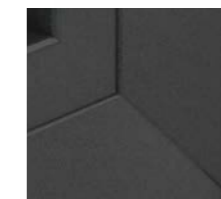

The option to choose V-Perfect weld.

Equipped with full 2-millimeter reinforcement in the frame and leaf (closed).

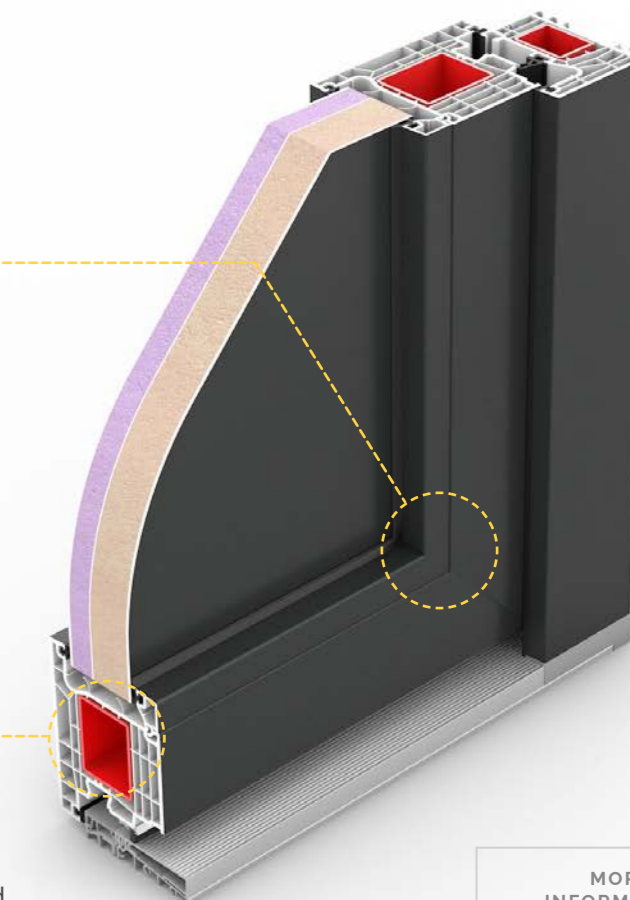

MORE INFORMATION



IGLO ENERGY SYSTEM

Iglo Energy doors are synonymous to modern design, energy efficiency, beautiful model manufacture, aesthetics and perfect functionality. Great thermal insulation parameters of the doors are a result of using high quality constructional materials, as well as including a specially designed threshold with a thermal break and innovative sealing system.



The option of producing the doors using V-Perfect technology (so-called thin weld).

TECHNICAL DATA



82 mm

installation
depth



$U_d = 0,8 \text{ W}/(\text{m}^2\text{K})^*$

thermal
transmittance

* More data at p. 111.



SYSTEM STRUCTURE

Frame made of 7-chamber PVC system.
Installation depth of the system amounts to 82 mm.

Extra Options Available:

- Swisspacer Ultimate warm spacing edge in 3 colour variants.
- Client proposed infill design made of mullions, glass and infill panel.
- The option of producing the doors using V-Perfect technology (so-called thin weld).
- A wide range of Renolit foil colours on white and brown core (p. 64).
- 3-winged hinges.
- 22,5 mm to 49,5 mm thick infill (glass) and 24, 36 or 48 mm thick batch panel.

S As Standard:

- 3-point espagnolette
- 3 two-winged hinges
- $U_g = 1,1 \text{ W}/(\text{m}^2\text{K})$ glass
- threshold with a thermal break
- aluminium handle.



The option to choose V-Perfect weld.

24, 36 or 48 mm
thick batch panel.

Equipped with full 2-millimetre
reinforcement in the frame and
leaf (closed profile).

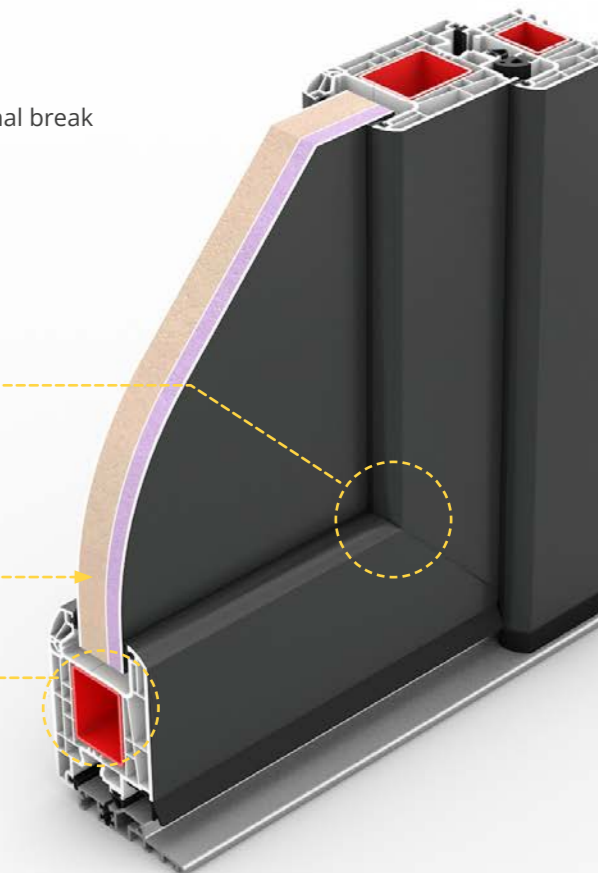

Glass with increased acoustic insulation, toughened, laminated (safety and anti-burglary), ornamental, sun protective, and sandblasted glass.



Sidelights (p. 100-101).



An espagnolette with a motor, equipping it to work with a smart access system.



A "day/night" type of espagnolette (recommended when choosing a pull handle).

* 1 mm aluminium thermal break available as an option

D

MORE
INFORMATION



IGLO 5 SYSTEM

These have a perfect combination of aesthetics, innovative solutions and functionality. The doors are equipped with an aluminium threshold with a thermal break as standard.



The option of producing the doors using V-Perfect technology (so-called thin weld).

TECHNICAL DATA



70 mm
installation
depth



Ud = 1,0 W/(m²K)*
thermal
transmittance

* More data at p. 111.



SYSTEM STRUCTURE

Frame made of 5-chamber PVC system.
Installation depth of the system amounts to 70 mm.

Extra Options Available:

- Swisspacer Ultimate warm spacing edge in 3 colour variants.
- Client proposed infill design made of mullions, glass and infill panel.
- The option of producing the doors using V-Perfect technology (so-called thin weld).
- A wide range of Renolit foil colours on white and brown core (p. 64).
- 22,5 mm to 41 mm thick infill (glass) and 24 or 36 mm thick batch panel.

S As Standard:

- 3- point espagnolette
- 3 two-winged hinges
- Ug = 1,1 W/(m²K) glass
- threshold with a thermal break
- aluminium handle
- mounting insert
- opening to the inside.



The option to choose V-Perfect weld

24 or 36 mm thick batch panel

1 mm aluminium thermal break as an option

Equipped with full 2-millimeter reinforcement in the frame and leaf (closed).



Glass with increased acoustic insulation, toughened, laminated (safety and anti-burglary), ornamental, sun protective, and sandblasted glass.

3-winged hinges.

Sidelights (p. 100-101).

A "day/night" type of espagnolette (recommended when choosing a pull handle).



MORE INFORMATION



PVC DOORS INFILL DESIGNS

In Drutex's offer, there are many infill models dedicated to PVC doors. These models enable the design to be adopted to the aesthetics of the house or apartment interior, as well as to the form of the building, allowing for architectural consistency.

INFILL
DESIGNS



i Each glazing spacer bar is available in grey (INOX) or black.



**ALASKA 1
DECORATIVE FRAME**



ALASKA 1



**ALASKA 2
DECORATIVE FRAME**

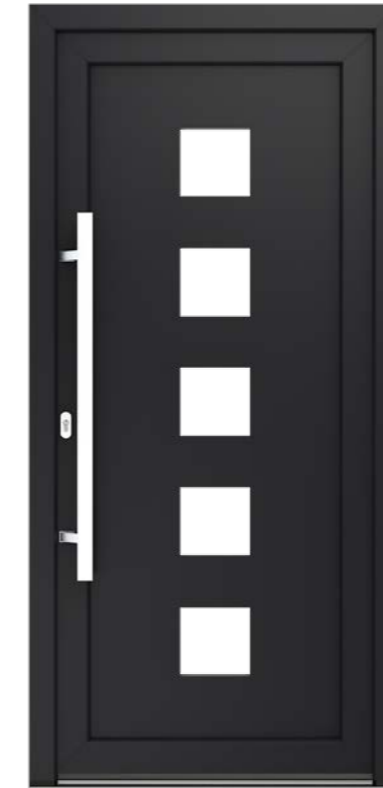

ALASKA 2



**ARIZONA 1
DECORATIVE FRAME**



ARIZONA 1

L - Left R - Right C - Center - configuration of the pattern position relative to the centre of the panel.

PVC DOORS INFILL DESIGNS



i Each glazing spacer bar is available in grey (INOX) or black.



**ARIZONA 2
DECORATIVE FRAME**



ARIZONA 2



**ALASKA 4
DECORATIVE FRAME**



ALASKA 4



**FLORIDA
DECORATIVE FRAME
(L) (R)**

The option to order in mirror image.



**FLORIDA
(L) (R)**



**CALIFORNIA 1
DECORATIVE FRAME
(L) (R) (C)**

The option to order in mirror image.



**CALIFORNIA 1
(L) (R) (C)**

L - Left R - Right C - Center - configuration of the pattern position relative to the centre of the panel.

PVC DOORS INFILL DESIGNS

i Each glazing spacer bar is available in grey (INOX) or black.



**COLORADO
DECORATIVE FRAME**

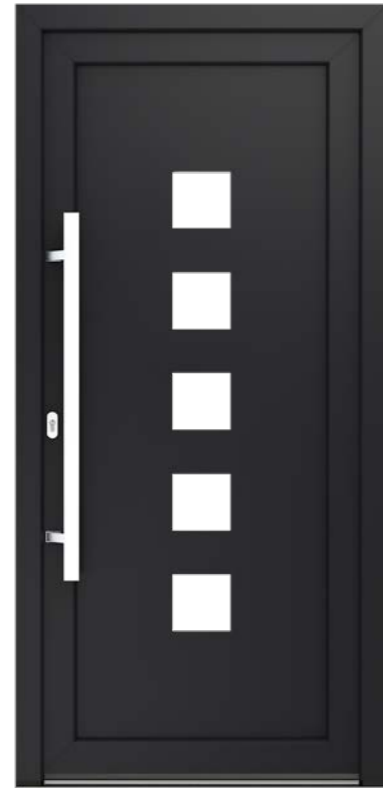

COLORADO



HAWAII 1



**HAWAII 2
DECORATIVE FRAME**



**HAWAII 3
DECORATIVE FRAME**



**MONTANA 1
DECORATIVE FRAME**



MONTANA 1



**MONTANA 2
DECORATIVE FRAME
(L) (R)**

The option to order in mirror image.

L - Left R - Right C - Center - configuration of the pattern position relative to the centre of the panel.

PVC DOORS INFILL DESIGNS



i Each glazing spacer bar is available in grey (INOX) or black.



**MONTANA 3
DECORATIVE FRAME
(L) (R)**

The option to order in mirror image.



**MONTANA 3
(L) (R)**

The option to order in mirror image.



**NEBRASKA
DECORATIVE FRAME
(L) (R) (C)**

The option to order in mirror image.



**NEBRASKA
(L) (R) (C)**

The option to order in mirror image.



**OHIO
DECORATIVE FRAME**



OHIO

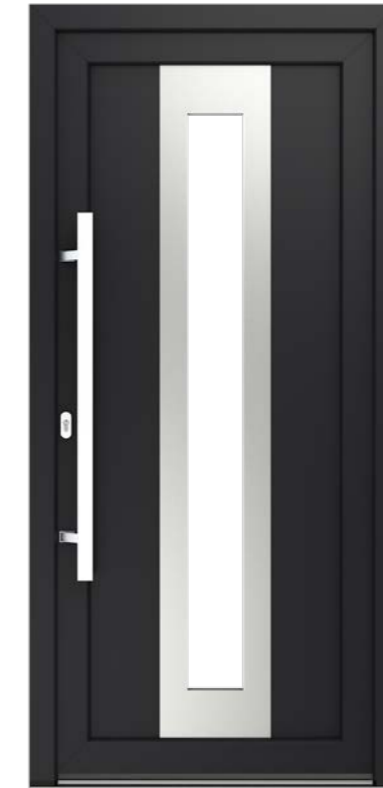

**TEXAS
DECORATIVE FRAME
(L) (R) (C)**



**TEXAS
(L) (R) (C)**

L - Left R - Right C - Center - configuration of the pattern position relative to the centre of the panel.

PVC DOORS INFILL DESIGNS

i Each glazing spacer bar is available in grey (INOX) or black.

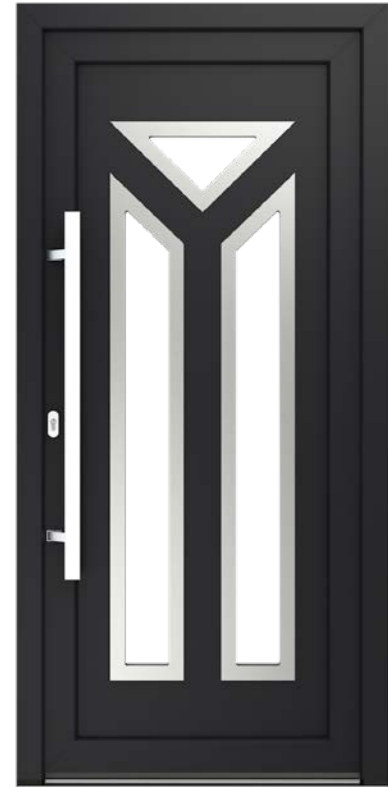

**PENNSYLVANIA 1
DECORATIVE FRAME**



PENNSYLVANIA 1



**PENNSYLVANIA 2
DECORATIVE FRAME
(L) (R)**

The option to order in mirror image.



**PENNSYLVANIA 2
(L) (R)**

The option to order in mirror image.



**PENNSYLVANIA 3
DECORATIVE FRAME
(L) (R)**

The option to order in mirror image.



**PENNSYLVANIA 3
(L) (R)**

The option to order in mirror image.



**NEW JERSEY
DECORATIVE FRAME**

Only available with steel rail.



NEW JERSEY

Only a steel spacing edge can be used.

L - Left R - Right C - Center - configuration of the pattern position relative to the centre of the panel.

PVC DOORS COLOURS

The rich Iglo Energy and Iglo 5 doors colour scheme combined with the wide range of infills allows for almost unlimited possibilities of matching the design and aesthetics of the doors to the client's personal preferences and needs. The excellent quality of the Renolit foils used in the production guarantees the highest quality, colour durability and lasting.



* Printout may differ from reality.



IGLO ENERGY SYSTEM

Windows and doors with sidelights, produced in Iglo Energy system, anthracite colour.



Windows and doors with sidelights, produced in Iglo Energy system, RS Styrofoam roller shutters, light grey colour.



IGLO ENERGY SYSTEM

Iglo HS, PSK Iglo Energy, TEXAS Inox front doors with fanlight, anthracite colour.



Iglo HS, PSK Iglo Energy, TEXAS INOX front doors with fanlight and sidelight, anthracite colour.





SOFTLINE 68, 78, 88 WOODEN DOORS

Exterior wooden doors in the Softline system made of pine or meranti wood are distinguished, not only by their high quality and elegance, but they also meet rigorous constructional requirements, simultaneously ensuring a high level of security and comfort of use.

CHARACTERISTICS

p. 72

COLOUR SCHEME

p. 75

EXTRAS

p. 78

**SOFTLINE 68, 78, 88
SYSTEM DOORS**

The highest quality wood used for production, glued in 3 layers, 68 mm thick, are the basis of classic design, high durability, high stability of the doors and the highest production quality. Drutex wooden doors, nevertheless, are more than just elegant in design and sophisticated in look, they are also excellently insulated. The doors are equipped with an aluminium threshold with a thermal break, as standard.

TECHNICAL DATA



68, 78, 88 mm
installation
depth



dla 68 Ud=1,1 W/(m²K)*
dla 78 Ud=0,9 W/(m²K)**
dla 88 Ud=0,85 W/(m²K)***
thermal transmittance

Ud values for single-leaf doors 1100 x 2300 mm:

* for 68 mm with 4/10/4/10/4 glazing and Swisspacer Ultimate spacer

** for 78 mm with 4/16/4/16/4 glazing and Swisspacer Ultimate spacer

*** for 88 mm with 4/18/4/18/4 glazing and Swisspacer Ultimate spacer





* More data at p. 111.



SYSTEM STRUCTURE

The doors are made of three-layer or four-layer square timber based on meranti or pine wood. The installation depth amounts to 68 mm.



Extra Options Available:

-  Swisspacer Ultimate warm spacing edge in 3 colour variants.
-  Client proposed infill design made of mullions, glass and infill panel (p. 108-109).
-  The choice of colour from azure and opaque paints (p. 75).
-  The addition of sidelights (p. 100-101).
-  The addition of 24 mm to 32 mm thick glass.

S As Standard:

- 3- point espagnolette
- 3 roller hinges
- 3 gaskets
- Ug from 0,5 to 1,1 W/(m²K) glass
- azure and opaque paints
- threshold with a thermal break
- aluminium handle
- mounting insert



-  Possibility of applying horizontal, vertical and oblique cutters.
-  Possibility of producing 140 mm thick leaf (110 mm as standard).
-  The addition of glass with increased acoustic insulation, toughened, laminated (safety and anti-burglary), ornamental, sun protective, and sandblasted glass.

MORE
INFORMATION



WOODEN DOORS COLOUR SCHEME

The rich range of opaque paints, provides 100% protection for the wooden structure. Transparent paints (azure) emphasise the structural characteristics of the given wood type and display the appropriate tint at the same time. The wooden exterior doors are a perfect solution for clients who value not only classic designs but also modern trends.



PINE ILLUSTRATIVE COLOURS

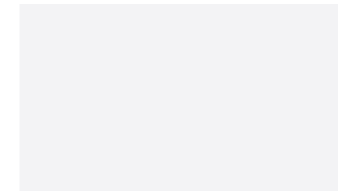

White (opaque)



Light Oak



Teak



Mahogany

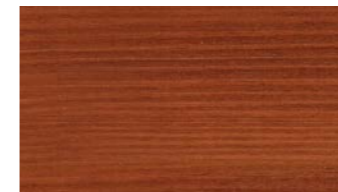

Dark Oak



Nut



Palisander



Colorless

MERANTI ILLUSTRATIVE COLOURS



Light Oak

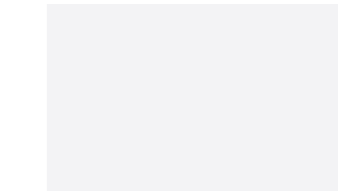

White (opaque)



Meranti Mahogany



Teak



Nut



Dark Oak

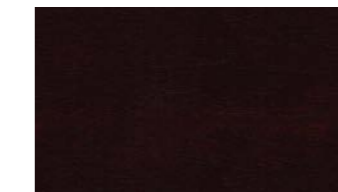

Palisander



Colorless

i Depending on the type of wood used, the colour may differ from the pattern.

*Printout may differ from reality.

Additionally, non-standard opaque colors according to the RAL palette and translucent finishes according to the Sikkens color range are available. Unpainted joinery is also offered – either with a colorless wood preservative or as raw wood.

SOFTLINE 68 SYSTEM

Windows and doors with sidelight and fanlight, produced in Softline 68 system, meranti wood, light oak colour.



Windows and doors with sidelight and fanlight, produced in Softline 68 system, meranti wood, palisander colour.



GLASS

When choosing the front doors with glass, it is necessary to take into account the different types of glass available, ranging from energy-saving through acoustic, safe, anti-burglary, sun protective and also glass with limited transparency, ornamental and matt.



MORE DESIGNS



GLASS TYPES

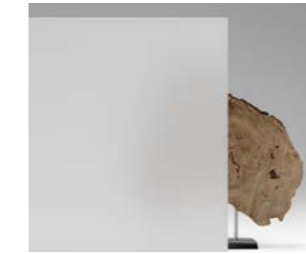

Matt



Sandblasted stripes*



Reflektofloat brown 6 mm



Reflektofloat blue 6 mm



Chinchilla Ornament



Delta Ornament



Silvit Ornament

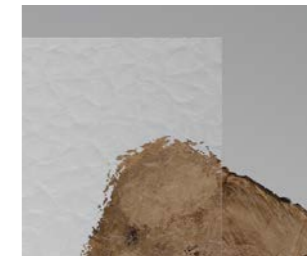

Cathedral Ornament

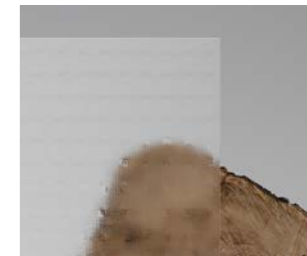

Master Carre Ornament

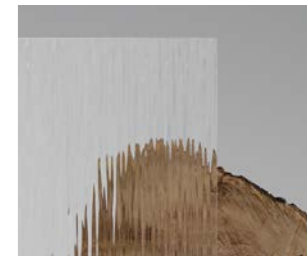

Rain Ornament



Antisol Green



Antisol Brown



Antisol Grey



Antisol Blue



Float 4, 6, 8, 10 mm
Option of applying thermal coating.



Laminated Glass
Option of applying thermal coating.



Black Line



Mirastar

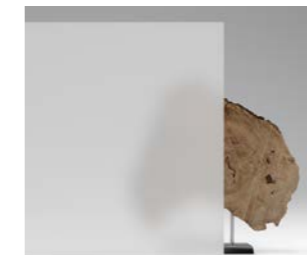

Satin matt

* For sandblasted glass, please contact the Drutex technology department or our dealer.

SANDBLASTED GLASS

NEW!

New technology of sandblasted glass production allows achievements in high levels of individualism and personalisation of door projects. Besides the wide range of standard patterns, it is possible to produce any graphics. Notably, the sandblasting process can be applied on both sides of the glass.



MORE DESIGNS



ILLUSTRATIVE PATTERNS OF SANDBLASTING

- i** possibility of making any graphics in agreement with the manufacturer
- i** possibility of sandblasting in 3 tints of grey



Example no. 1



Example no. 2

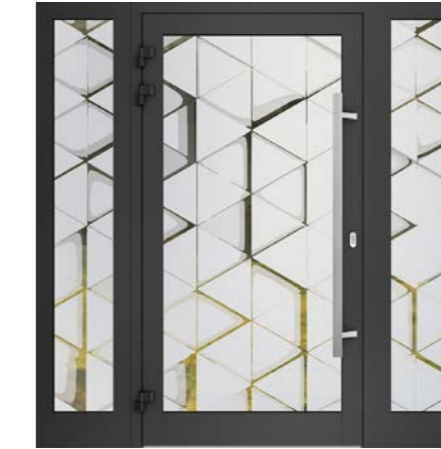

Example no. 51



Example no. 52



Example no. 5



Example no. 6



Example no. 32



Example no. 53

ILLUSTRATIVE PATTERNS OF SANDBLASTING

i possibility of making any graphics in agreement with the manufacturer

i possibility of sandblasting in 3 tints of grey



Example no. 9



Example no. 10



Example no. 11



Example no. 26

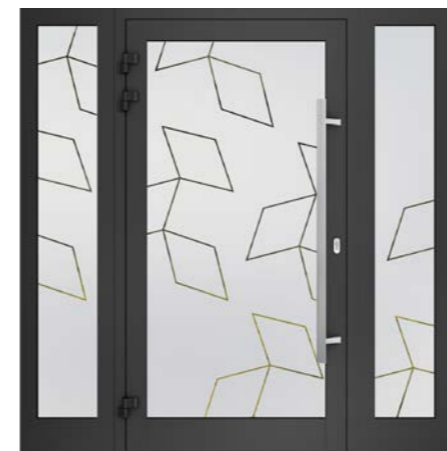

Example no. 17



Example no. 18



Example no. 13



Example no. 14



Example no. 15



Example no. 54



Example no. 19



Example no. 20



Example no. 56

PULL HANDLES

Pull handles used for front doors are distinguished not only by their high aesthetic properties, but also by their functionality and durability. It is highly recommended to include with the pull handles: "day/night" espagnolette and smart access systems, which further enhance the functionality.



MORE



HANDLES

Handles used for front doors are distinguished not only by their high aesthetic properties, but also by functionality and durability. Because of the large range of colour variants, it is possible to match handles with both the door and building colours.



MORE



GY



ACCESS CONTROL

Ensuring security is an imperative and important door function. Therefore, Drutex doors can be optionally equipped with systems ensuring a high security level and at the same time providing protection against burglary.

Doors equipped with smart access control systems guarantee both, functionality and comfort of use.



EXTRAS



Fingerprint reader, keyboard, and RFID.



Ekey keyboard (black).



Ekey keyboard (steel).



IDENCOM keyboard.



INDECOM RFID reader.



INDECOM fingerprint reader.



SOMMER reader.



EKEY fingerprint reader (steel).



Fingerprint EKEY dLine.



SMART HOME

Open and close doors remotely or on site! TaHoma Somfy automatics allow for adjustment of all home devices to meet the client's needs.

Advantages

With a smartphone, clients can achieve constant supervision and, if necessary, access to systems installed in the house at any time of the day or night.

DOORBOX SYSTEM

Open doors, wickets, gates, control lighting, roller shutters and venetian blinds from any place in the world.



Integrated, miniature driver of: electric bolts, electro-catches, and safety valves intended for access control.

Advantages

- works with virtually all electric locks on the market.
- allows the allocation of access to multiple people--family, gardener, friends.
- does not require any extra devices.
- allows the control of multiple access points from a single application.
- close/open control in real time.



Home Application for a Smartphone



Using the wBox home application with a smartphone enables management of all automatics in the garden or home. This can be accessed from the internet with the home WiFi or from anywhere in the world.

THRESHOLDS

The threshold is an extremely important element of the doors. Not only, does it determine the energy efficiency values of the system, but also the comfort of use.

Aluminium Threshold with a Thermal break

Used mainly for exterior doors, perfectly stiffens the structure and improves the comfort of use.

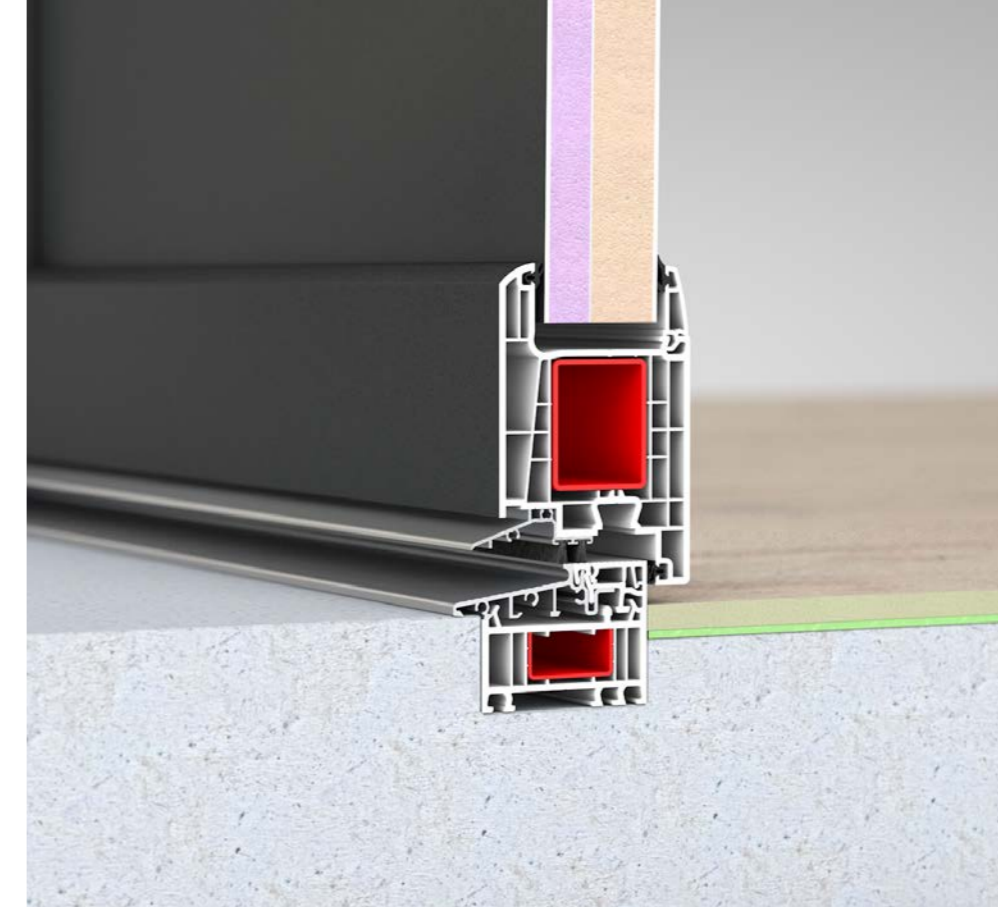
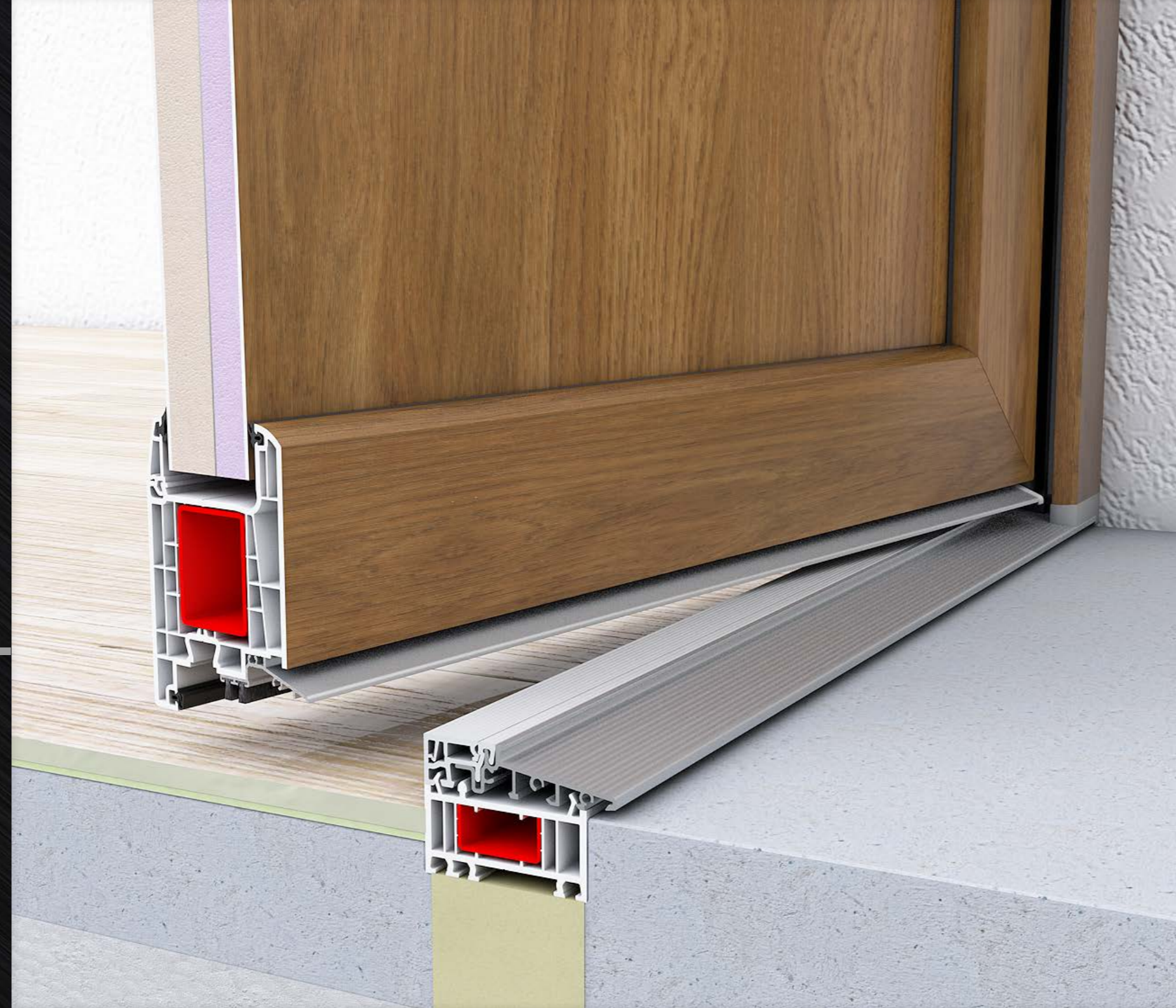

Combi Threshold

It is a perfect fit for interior and exterior doors, distinguished by very good thermal insulation values.

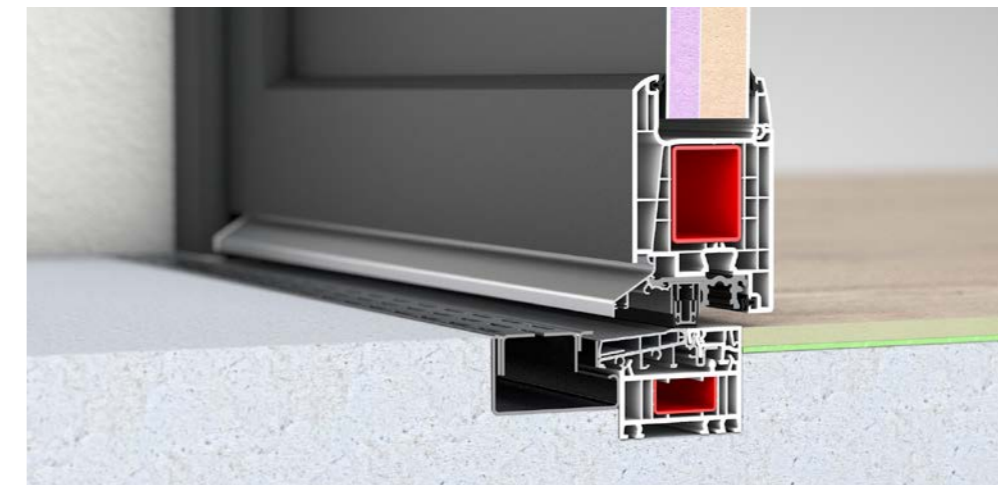

Zero Threshold

Combi Plan 0 mm threshold. May be aligned with the finished floor, with the option to use with linear drainage.

TYPES OF THRESHOLDS FOR INDIVIDUAL SYSTEMS

MB-45



Threshold with a visor (as standard).

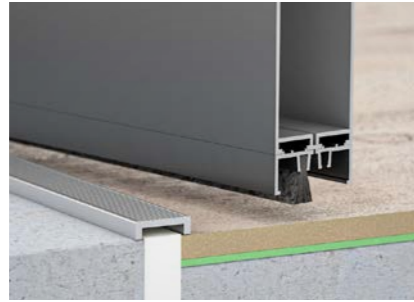

Low threshold (7,5 mm high).

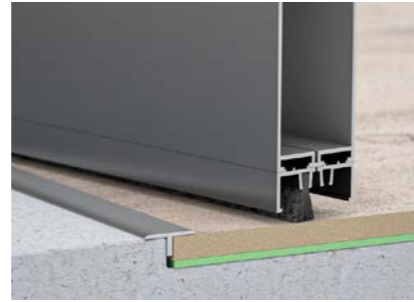

No threshold, brush.



Threshold with an automatic gasket.

MB-79N SI



Standard threshold.

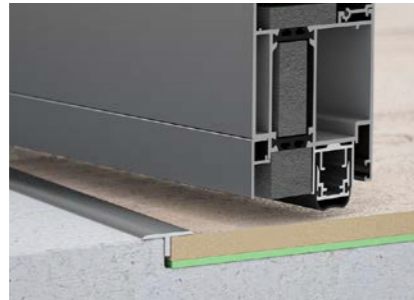

Threshold with an automatic gasket.

MB-86 SI

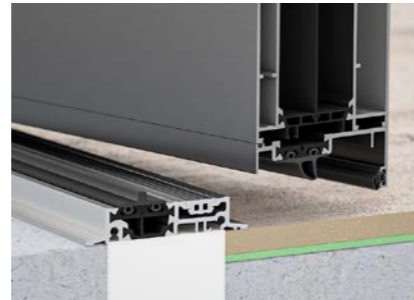

Standard threshold.

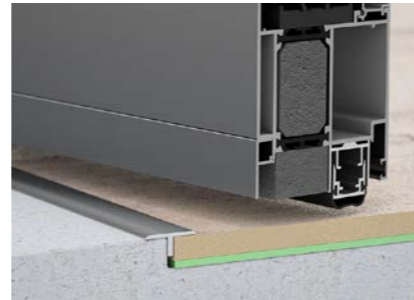

Threshold with an automatic gasket.

SOFTLINE 68

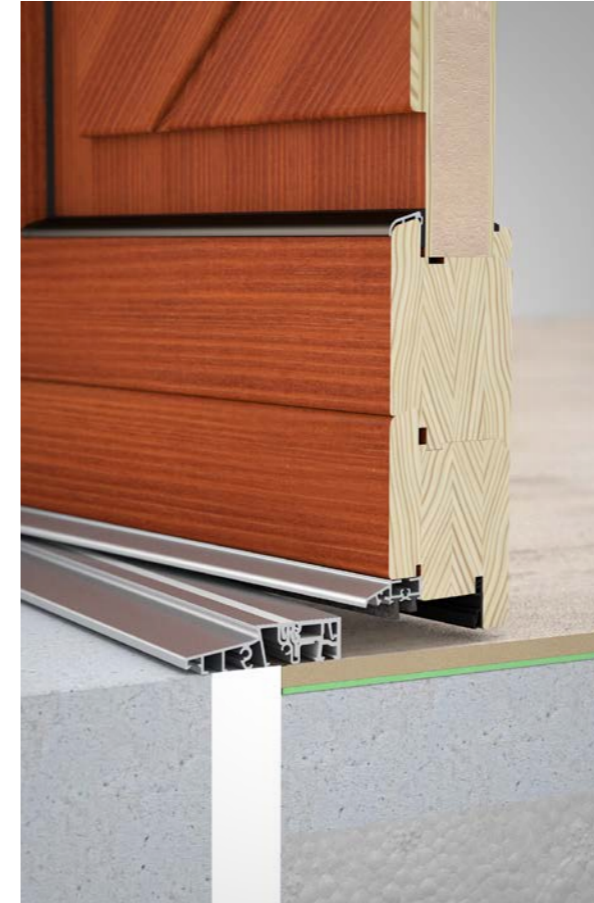

Standard threshold.



EXTRA EQUIPMENT

Modern exterior doors fulfil many different functions and the choice of elements constituting the extra equipment in the form of letterboxes, hinges, spyholes, or so called self-closers, determines the aesthetics, durability, and comfort of use.

Letterbox



OTHER



Spyhole

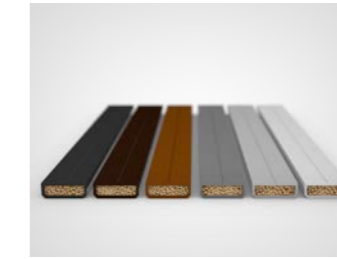

Swispacer Ultimate warm edge available colours:



Electro-catches



Locking sensor

HINGES



Roller hinge for aluminium



3-winged hinge for aluminium



Hidden hinge for aluminium



3-winged hinge for PVC

SELF-CLOSERS



DORMA TS PROFILE
Standard rail or with a blockage. Available colours: white, grey, black.



DORMA TS93 BASIC
Standard rail or with a blockage. Available colours: white, grey, brown, black.



GEZE BOXER.

DOORS WITH EXTRA SECURITY EQUIPMENT

Safe front doors are an investment of peace and comfort in life for residents. Aluminium exterior doors, produced in accordance with the RC2 norm, provide safety, design, and acoustic insulation simultaneously. Anti-burglary doors are secure from being opened with tools such as crowbars or screwdrivers. Available also in the PVC system.



ESPAGNOLETTE

Doors equipped with an automatic espagnolette is an investment in security, as it provides increased protection. An espagnolette guarantees constant pressure on the entire height of the doors, which results in tightness and thermal insulation. The easy and silent closure is another important feature, because of the standard cranked pawls.



Automatic Door Espagnolette

The option of integration with a motor and access control system.

INSERT PLATE WITH ANTI- BURGLARY PROTECTION

Ensures anti-drill protection. Available only and exclusively in MB-86 SI system doors in the RC2 anti-burglary class.



Anti-theft Pins

i A class C lock cylinder is used in the RC2 system.



ROSETTE SOBINCO
DO RC2

MB-78 EI FIRE-RATED DOORS

An undesirable event, that is feared and planned to avoid, is a fire. When in the home, fire-rated doors may be useful in separating the boiler room from the rest of the house. The use of fire-rated doors in large construction projects, such as office buildings and factories, is a necessary requirement. These doors close fire zones, limiting losses in the case of fire and in many situations protecting human life.



FIRE-RATED

Drutex fire-rated doors are an integral part of a technically advanced fireproof system, which is characterised by both tightness and fire insulation. The system achieves a fire resistance class of EI30 to EI60. Durable and solid system construction is guaranteed because of the stable aluminium profile which includes being equipped with special profiled thermal breaks.



ADVANTAGES:

-  thermally insulated aluminium profiles with a depth of 78 mm
-  fire-rated glass, with options to choose from a range of glass types
-  fittings meeting fire-rated requirements
-  special swelling and ceramic sealing, preventing smoke and fire access
-  wide range of RAL colours, special colours and structures (p. 40-41)
-  20 mm to 45 mm and 47 mm to 49 mm thick glass infill.



DOOR CONSTRUCTIONS

Modern architecture often requires the construction of doors to have varied dimensions, shapes, or specifications. Not only do these elements determine the appearance, but also the usability, the stability and durability of the doors.



MORE
LAYOUTS



THE OPTION OF SIDELIGHT(S)

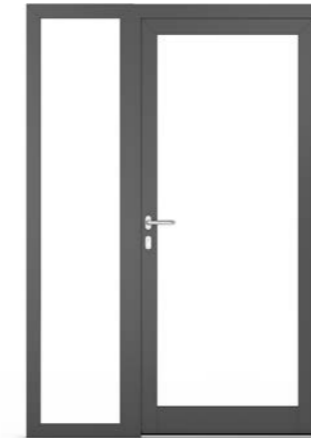

Option No. 1

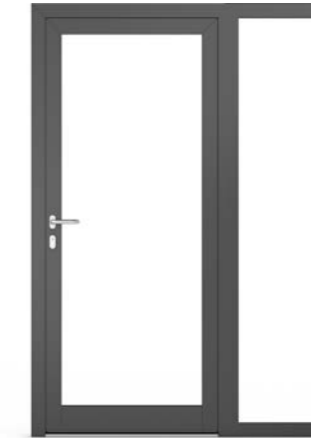

Option No. 2

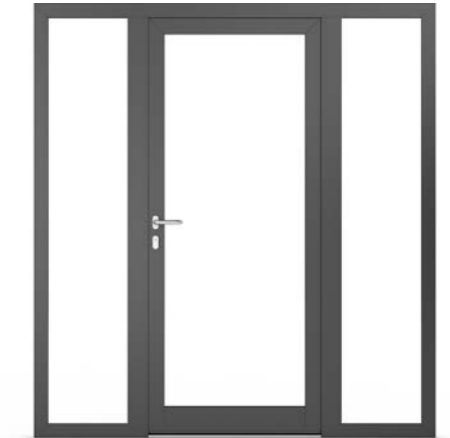

Option No. 3

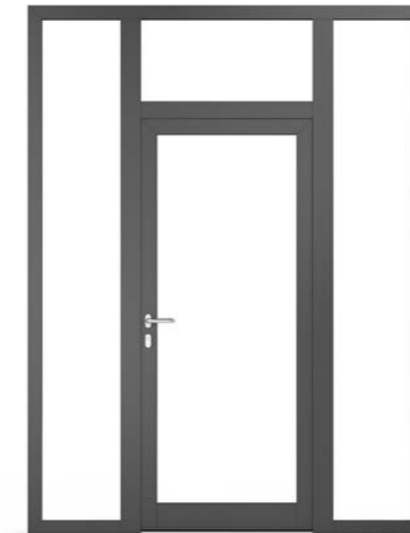

Option No. 4

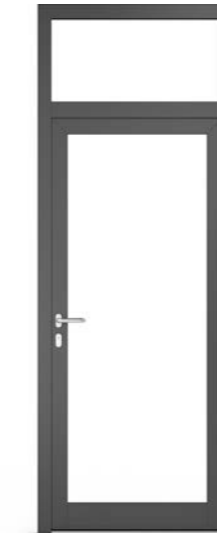

Option No. 5

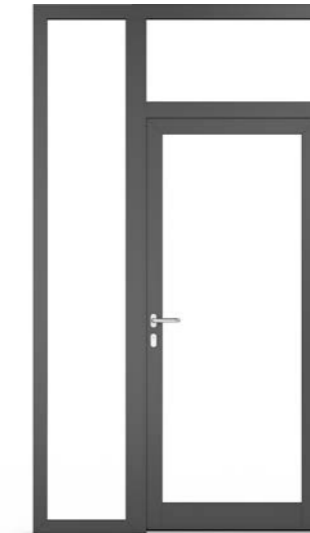

Option No. 6



Option No. 7

ANTI-PANIC FITTINGS

Security in a specific building can depend on quick and efficient evacuation. With the effect of pressure, panic, and real threats, public buildings have to provide for the evacuation of premises in the shortest possible time. Therefore, the anti-panic fittings used in doors is a product which directly influences security, health and life.



SURFACE

Anti-panic rod meeting the highest standards of security.



GROOVE

Option of applying anti-panic rod or handle.



MULLIONS IN ALUMINIUM AND PVC DOORS



MULLIONS



EXAMPLES OF MULLION PATTERNS



Example No. 1



Example No. 2



Example No. 3



Example No. 4

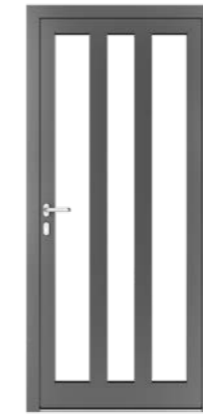

Example No. 5



Example No. 6



Example No. 7



Example No. 8



Mullions used in Drutex doors not only increase the stability of a door, but also allow for unique and individualised aesthetics.



MULLIONS



EXAMPLES OF MULLION PATTERNS



Example No. 9



Example No. 10



Example No. 11



Example No. 12



Example No. 13



Example No. 14



Example No. 15



Example No. 16



MULLIONS IN WOODEN DOORS

SOFTLINE 68, 78, 88

A wide range of mullion patterns allows for stylistic consistency with the exterior and interior architecture of the building.



MULLIONS



Example No. 1



Example No. 2



Example No. 3



Example No. 4



Example No. 5



Example No. 6



Example No. 7



Example No. 8

SYSTEM COMPARISON

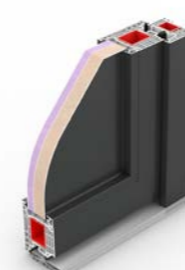

INFORMATION	MB-86N SI	MB-79N SI	MB-45	MB-78 EI FIRE-RATED	IGLO EDGE	IGLO ENERGY	IGLO 5	SOFTLINE 68, 78, 88
MATERIAL	ALUMINIUM	ALUMINIUM	ALUMINIUM	ALUMINIUM	PVC	PVC	PVC	MERANTI or PINE
COLOURS	RAL mat, RAL fine structure, RAL metallic, wood-like, anodes	RAL mat, RAL fine structure, RAL metallic, wood-like, anodes	RAL mat, RAL fine structure, RAL metallic, wood-like, anode	RAL mat, RAL fine structure, RAL metallic, wood-like, anodes	Renolit	Renolit	Renolit	RAL and AZURE colours
INSTALLATION DEPTH	77 mm	70 mm	45 mm	78 mm	82 mm	82 mm	70 mm	68, 78, 88 mm
UD	Ud=0,83 W/(m²K)*	Ud=1,0 W/(m²K)**	internal application	Ud=1,7 W/(m²K)*****	Ud=0,8 W/(m²K)**	Ud=0,8 W/(m²K)**	Ud=1,0 W/(m²K)***	for 68 Ud=1,1 W/(m²K)**** for 78 Ud=0,9 W/(m²K)**** for 88 Ud=0,85 W/(m²K)**
V-PERFECT WELD	No	No	No	No	Yes*****	Yes*****	Yes*****	Nie
INFILL	15-60 mm (glass) 36 mm (batch panel) 77 mm (overlay panel)	16-53 mm (glass) 36 mm (batch panel)	6-28 mm (glass)	20-45 mm (glass) 47-49 mm (glass) batch panel	22,5-49,5 mm (glass) 48 mm (batch panel) Custom configuration of mullions, glazing, and panel	22,5-49,5 mm (glass) 48 mm (batch panel) own design with mullions, glass and panel	22,5-41 mm (glass) 36 mm (batch panel) own design with mullions, glass and panel	24-54 mm (glass) own design with mullions, glass and panel
STANDARD ESPAGNOLETTE	3-point automatic	3-point automatic	3-point automatic	single lock	3-point automatic	3-point automatic	3-point automatic	3-point hook
ESPAGNOLETTE WITH AN EXTRA CHARGE	„day/night” type of espagnolette, 5-point lock, 1 lock	„day/night” type of espagnolette, 5-point lock, 1 lock	„day/night” type of espagnolette, 5-point lock, 1 lock	1 lock	„day/night” type of espagnolette, hook and bolt	„day/night” type of espagnolette, hook and bolt	„day/night” type of espagnolette, hook and bolt	3-point automatic 5-point hook
STANDARD HINGES	3 two-winged hinges for both-side aligned doors	3 two-winged hinges	3 two-winged hinges	3 or 4 two-winged hinges	3 two-winged hinges	3 two-winged hinges	3 two-winged hinges	3 roller hinges
HINGE OPTIONS	3-winged, roller, hidden hinges	3-winged, roller, hidden hinges	3-winged hinges	3-winged hinge	3-winged hinge	3-winged hinge	3-winged hinge	4 or 5 rollers

Calculation of the Ud coefficient carried out for a single-leaf doors with dimensions of 1100x2300 mm, applies to p. 98:

* for doors in WASHINGTON ZERO model with both-side aligned panel.

** glass with argon and Swisspacer Ultimate TMP4/U18/FL4/U18/TMP4 spacing edge.

Calculation of the Ud coefficient carried out for a single-leaf doors with dimensions of 1100x2300 mm, applies to p. 99:

** glass with argon and Swisspacer Ultimate TMP4/U18/FL4/U18/TMP4 spacing edge.

*** glass with argon and Swisspacer Ultimate TMP4/U14/FL4/U14/TMP4 spacing edge.

**** glass with argon and Swisspacer Ultimate TMP4/U10 /FL4/U10/TMP4 spacing edge.

***** Polflam glass EI30/S16/TMP4 ESG with galvanised steel spacing edge.

***** solution available with an extra charge depending on the market, in Poland without extra charge.

***** V-Perfect available everywhere at no extra cost.

SEE ALSO
WINDOWS



ROLLER SHUTTERS, VENETIAN
BLINDS, MOSQUITO NETS

Drutex is currently one of the leading producers of windows and doors in Europe. Not only, is it one of the most innovative and reliable polish brands, but also a calling card of polish entrepreneurship success' in the whole world.

The company, based in 100% on polish capital, from the beginning is managed by its founder, Leszek Gierszewski.

Thanks to the guaranteed high quality, rich offer, technological advancement, own laboratories, high efficiency of operation, really short lead and delivery time, year by year we grow our addressee net. Each product is custom-made, produced for a specific customer.

We offer PVC, aluminium, and wooden windows and doors, roller shutters, venetian blinds, facades, and winter gardens.

Window-door joinery, branded with the DRUTEX logo, reaches six continents.

We have been appreciated by millions of satisfied customers and independent experts, granting the company with many prestigious awards. The most important ones include: Forbes Diamond, EU Standard, European Medal, Superbrands Title, Plus X Award 2017.



up to 7000
windows daily



4000
employees



700+
vehicles



118 M sq. m
surface production

Fast delivery time



SINCE 1985

